



SUPERTECH[®]
genius of the tank



East West s.a.s.

Index

- 1.** *company*
- 2.** *product*
- 3.** *technical data*
- 4.** *results*
- 5.** *application*
- 6.** *references*



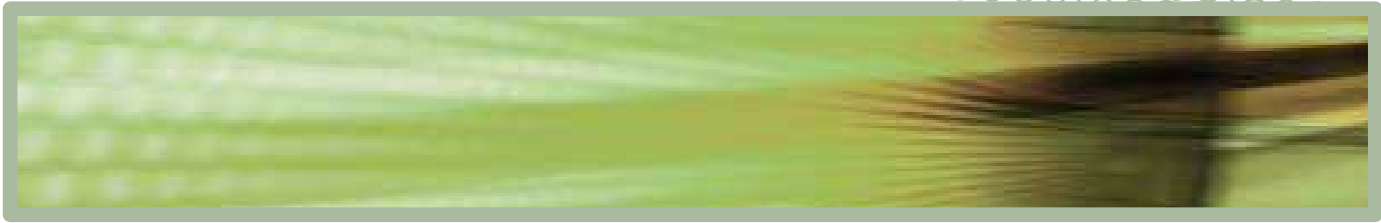

*"It is not the earth that belongs to man; it is man that belongs to the earth.
All that happens to the earth will happen to the children of the earth"*

In far 1988, our Group was already seeking for an ecologic product, SINCE during the last 100 years mankind had polluted the EARTH as never had been done in the previous 100.000 years, therefore now had come the time to start un-polluting.

1996

SUPER TECH PROJECT begins

2006

CREDIBILITY phase had been completed.

2008

The TRUE worldwide commercialisation phase begins THANKS to the strong CREDIBILITY obtained through tests and test reports issued by OPINION LEADERS from 23 different COUNTRIES.

2. product

The device is re-usable and can be re-installed in another vehicle.

The effective life of the SUPERTECH is always longer than its guaranteed period and frequently longer than the life of the vehicle in which it is installed. For this reason it is provided with a cable so it can be recovered from one vehicle to be re-installed in another. The device functions ONLY in moving vehicles and cannot therefore be used in heaters or steady boilers.

The device functions ONLY in hydrocarbon-driven engines (petrol, diesel and ethanol).

The device has been validated by independent laboratories, universities, government bodies, large transport fleets - private and public - which carry both goods and people, in twenty different countries. Its efficiency has been acknowledged through roll-bench laboratory tests and on the road.

Our reference book can be downloaded and provides a summary of the original documents which are retained by our General Management and can be obtained in their complete versions on request. Our device has today provided satisfaction for tens of thousands of users worldwide. The device is produced and distributed worldwide by one organization only, through a network of exclusive national distributors who, according to their contracts, are divided between:

Exclusive concessionaires

Exclusive commissionaires

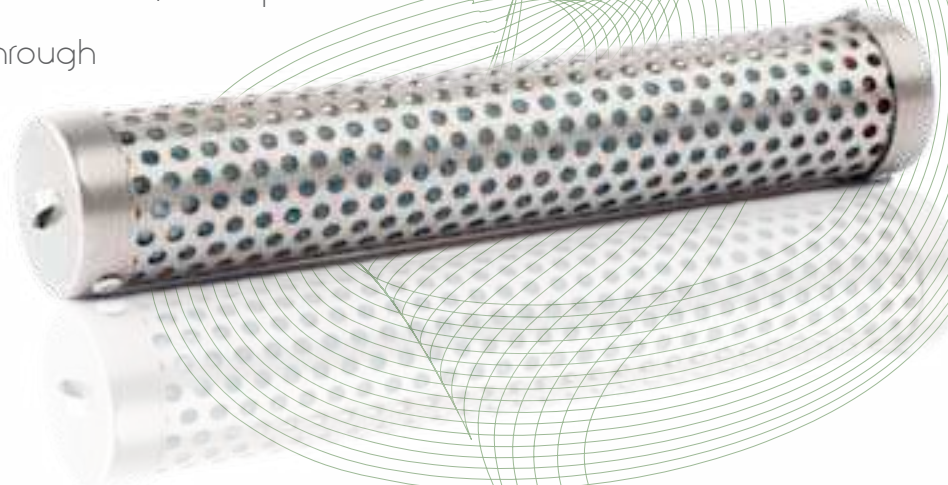

3. *technical datas*

Il Supertech® is a solid immersion device which functions inside the fuel tank of vehicles with hydrocarbon-driven engines (petrol, diesel and ethanol). There are five models of different size, providing a capability range for fuel tank capacity of up to 800 litres. Model A is the smallest with capability up to 40 litres fuel tank capacity. Model E is the largest with capability up to 800 litres fuel tank capacity. While the diameter of the five different models remains the same, the length changes.

1. Mod. A : length 80mm; fuel tank capacity up to 40 litres; Ø 30mm; weight: 90 gr.
2. Mod. B : length 120mm; fuel tank capacity up to 70 litres; Ø 30mm; weight: 120 gr.
3. Mod. C : length 160mm ;fuel tank capacity up to 150 litres; Ø 30mm; weight: 164 gr.
4. Mod. D : length 240mm; fuel tank capacity up to 350 litres; Ø 30mm; weight: 210 gr.
5. Mod. E : length 320mm; fuel tank capacity up to 800 litres; Ø 30mm; weight: 312 gr.

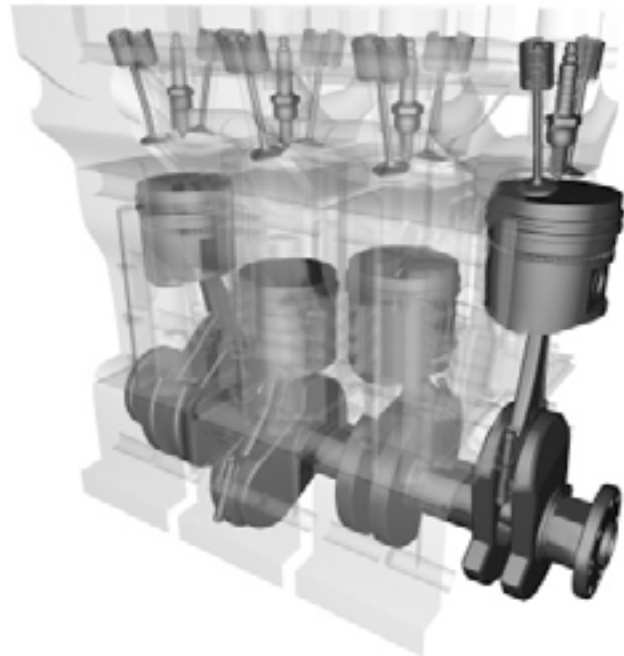

4. results



1

Fuel consumption reduction up to

2

3

Less manutence cost



5. application

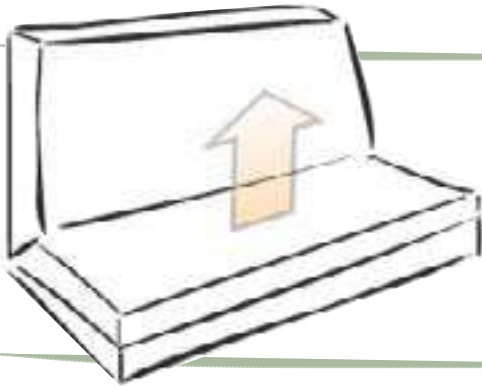

Lift back seat

Lift the seating part of the back seat.

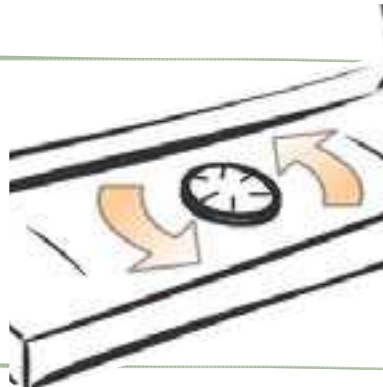

Turn off the lid

Turn off and lift the lid of the fuel pump to enable access to the pump.

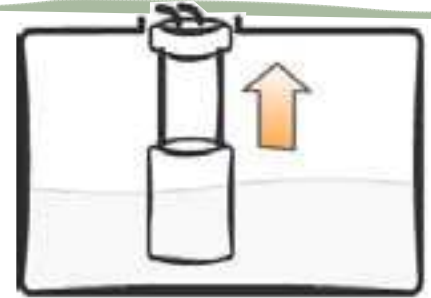

Pull the fuel pump

Pull the fuel pump carefully out of the tank.



Submerge SUPERTECH

Submerge the SUPERTECH until it touches the bottom of the tank so that leans at an angle between 5 and 10 degrees

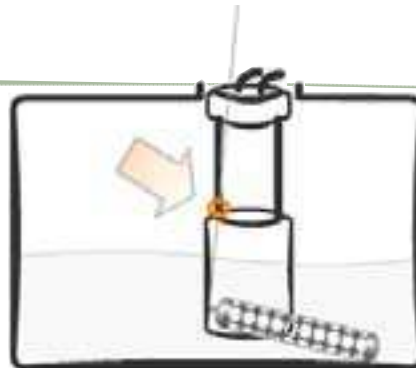

Fixing

Loop the SUPERTECH's steel cable around the fixed part of the pump, then put pump back in its position

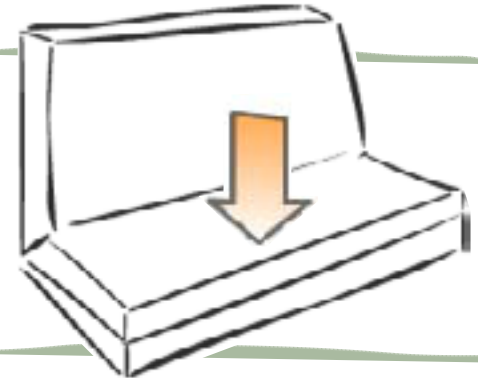

Close back seat

The excess of the steel cable can be either cut off or carefully wound inside the tank. Restore all in original position

Universities

FABET - Fundação Adolpho Bósio de Educação no Transporte (Brasile)
L'Università Helwan del Cairo
GFS - Golden Fame Holding Limited (Hong Kong)
Ing. Dennis Y. C. Leung - HONG KONG
LATVIA UNIVERSITY (Latvia)
TMTC LITUANIA
UNAM UNIVERSITY (Messico)
DAMASCUS UNIVERSITY (Sirya)
Institute of "Transport and Technologies" Dnepropetrovsk (Ucraina)
LATVIA UNIVERSITY (Latvia)

Government institutes

IBAMA - Instituto Brasileiro do Meio Ambiente (Brasile)
Sezione Trasporti Governo del Cile
DALIAN INSTITUTE (Cina)
Ministero dell'ambiente (Stato di Ganajuato)
Istituto di metrologia della Mongolia
Registro Automobilistico Rumeno

Transport persons

L'AMAT, Azienda Municipalizzata AutoTrasporti di Palermo
ZENIT - Grupo Flechabus (ARGENTINA)
RIMA TUR (Curitiba - Brasile)
SOUL - Sociedade de Ônibus União Ltda. (Brasile)
Trasporti Urbani di Teheran (Iran)
COMVERSE (Israele)
Connex Varsavia Sp. Z.o.o. (Polonia)
CANKAYA BELLEDIYESI (Turchia)
I.E.T.T. - (Turchia)
IZULAS (Turchia)
Libertas Dubrovnik d.o.o
BRAZIL - SUDESTE - COLLECTIVE TRANSPORTS

Transports of goods

GRUPPO COLORADO (Brasile)
COOPERCARGA (Brasil)
KONQUEST (Brasile)
Ouro e Prata-Cargas - Porto Alegre - BRASILE
OURO VERDE - Curitiba - Brasile
GRUPPO MONCASSIN (Francia)
COCA COLA (Israele)
SCHINDLER NECHUSHTAN ELEVATORS Ltd. (Israele)
GRUPPO Arcese S.p.a.
ALTO CARBONO (Messico)
PEMEX (Messico)
PETROM - ROMANIA
AK-EGE (Turchia)
ARAS CARGO - TURCHIA
CINAR (Turchia)
CP VAT LIEU (Vietnam)
Cong Ty co phan vat (Vietnam)
Hop Luc (Vietnam)

Laboratories

LACTEC (Brasile) e EME (Laboratorio Emissione dei Veicoli)
RETIMAO - Distributore Regionale di camions Volkswagen (Brasile)
TÜV di Lamsheim (Germania)
BTAC - British Transport Advisory Consortium (UK)
MOSAVTOPROGRESS di Mosca
Istituto tecnico dei veicoli militari (Vietnam)

Car manufacturers

MINITRA (Ungheria)
MITSUBISHI MM Import Kft. (Ungheria)



SUPERTECH®

Registered and Head office

East West s.a.s.

Via Veneto, 14 Palermo (Italy)

Phone.0039 091 308999

website: www.supertech.it

email. gina@supertech.it

email. luigi@supertech.it